











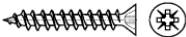
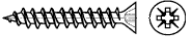

# BOSTON/WOOLDALE BUNK ASSEMBLY INSTRUCTIONS

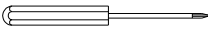

Please read & check through these instructions carefully before proceeding with assembly

<b>COMPONENTS</b>	
<b>Box 1 of 5 Bunk Ends &amp; Fittings</b>	1 x Lower Bunk End 1 x Upper Bunk End 1 x Instructions 1 x Fittings Pack (Including Knobs for use as single beds):
<b>Bunk Assembly</b>	
(A) 28 x M6 115mm Bolt	
(B) 28 x M6 Barrel Nut	
(C) 4 x M6 38mm Bolt	
(D) 4 x 25mm Woodcrews	
(I) 36 x 38mm Woodscrews	
(F) 1 x 4mm Allen Key	
<b>Ladder Assembly</b>	
(E) 8 x M6 30mm Bright Bolt	
(H) 2 x Ladder Hook	
(G) 4 x M4 20mm M/C Screws	
(J) 2 x 16mm Woodscrews	
<b>Box 2 of 5 Bunk Ends</b>	1 x Lower Bunk End 1 x Upper Bunk End
<b>Box 3 of 5 Rails &amp; Ladder</b>	3 x Plain Side Rails 1 x Ladder Side Rail 2 x Rear Safety Rails 2 x Short Ladder Side Rails 1 x Short Ladder Rail Jointing Piece 2 x Ladder Sides & 4 x Ladder Treads
<b>Box 4 of 5</b>	Mattress Slats
<b>Box 5 of 5</b>	Mattress Slats
<b>Tools Required (Not Supplied)</b>	 

This product is designed to conform to the latest safety regulations and we hope you will be happy with your purchase. This product is primarily produced from quality Scandinavian pine. As such you may find small knot or surface defects that are inherent with a natural resource and in no way compromise safety or functionality. Whilst every effort is made to ensure this product reaches you in good condition, in the unlikely event you find a problem with any component, **please do not attempt to assemble** – and contact your retailer. As you will appreciate, we cannot accept any liability for damage once an attempt to assemble had been made.

Cleaning: a damp cloth should be sufficient to keep this product in good order. Please do not use abrasive cleaning materials as this will incur damage. Thank you for choosing our product.

### 1 – Attach The Lower Bunk Side Rails

Take the 2 lower bunk ends from Box 1 and Box 2. Using 8 bolts (A) and 8 barrel nuts (B), attach 2 of the plain side rails to the bunk ends as shown. NB: Boston Bunk Ends can be assembled with grooved detail on the inside or outside.

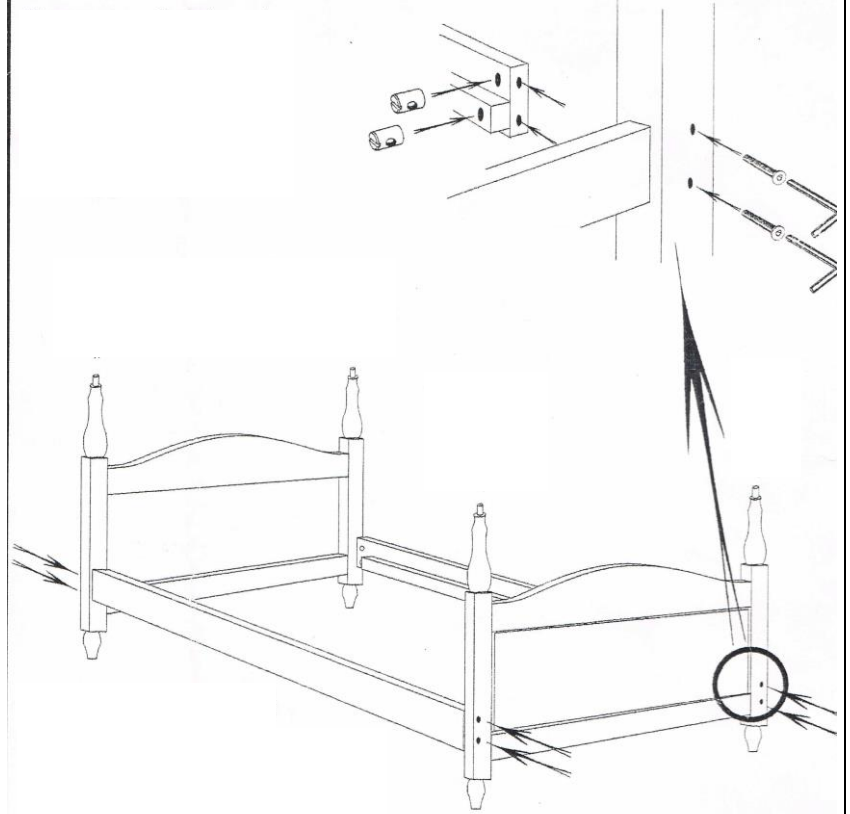

### 2 – Fit The Lower Bunk Mattress Slats

Spread one set of mattress slats (Box 4 or 5) out evenly on the support rails and fix with 12 woodscrews (I) as shown.

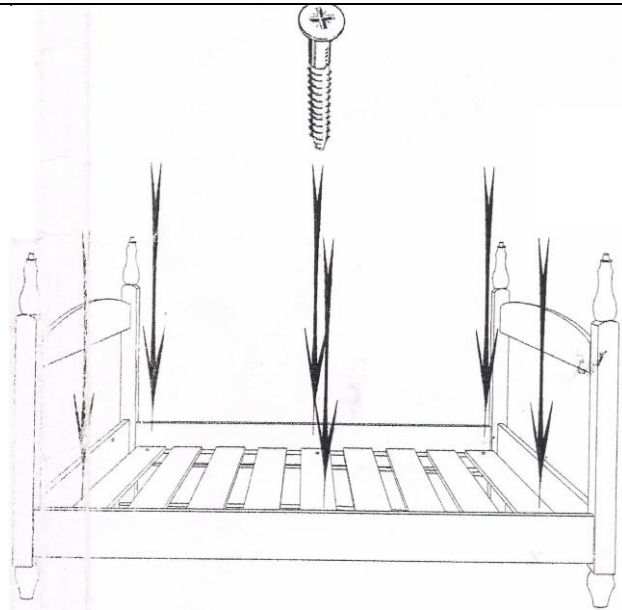

### 3 – Upper Bunk Assembly

Take the 2 upper bunk ends from Box 1 and Box 2. Using 8 bolts (A) and 8 barrel nuts (B), attach the remaining plain side rail and one ladder side rail (with holes for jointing piece) to the bunk ends as shown. NB: For the Boston Bunk ensure ends are assembled with grooved detail to match bottom bunk (see 1).

Spread the second set of mattress slats (Box 4 or 5) out evenly on the support rails and fix with 24 woodscrews (I). NB: For Safety all slats on the Upper Bunk must be fixed.

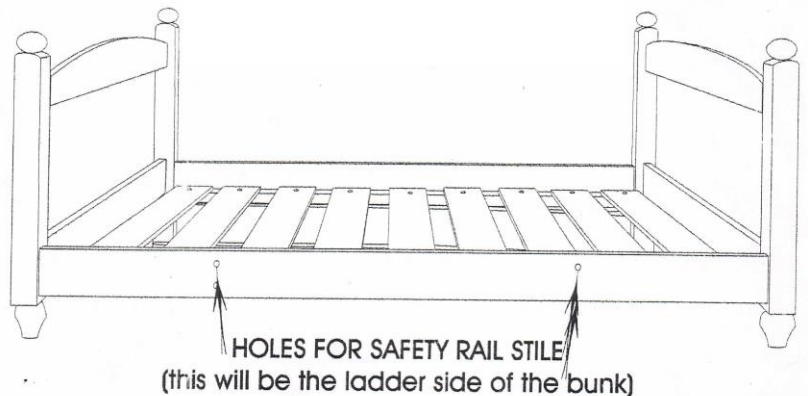

### 4 – Fit Safety Rails

- 1) Attach the 2 rear safety rails using 8 bolts (A) and 8 barrel nuts (B).
- 2) Choose which end you wish to have the ladder and using 2 bolts (C) loosely attach ladder jointing piece to the front side rail.
- 3) Attach the 2 short safety rails using 4 bolts (A) and 4 barrel nuts (B) at the leg.
- 4) Attach the ladder jointing piece to the short safety rails using 2 bolts (C).
- 5) Tighten all bolts on the ladder jointing piece.

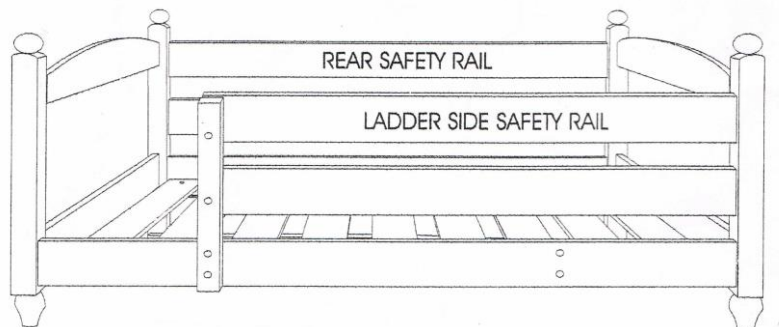

### 5 – Raising The Bunks

#### NB: 2 Persons Required

Lift the upper bunk onto the lower bunk, ensuring the stems from the lower bunk fit cleanly and simultaneously into the holes bored under the feet of the upper bunk.

Use 4 woodscrews (D) to lock each leg of the bunk together.



## 6 – Ladder Assembly

Assemble ladder sides & treads using 8 x 30mm bright bolts (E) with the Hexagon key taking care to avoid scratching the ladder sides.

Fit the ladder hooks using the 4 machine screws (G).

If you wish to secure the ladder in place, please use the 2 x 16mm woodscrews (J) provided.

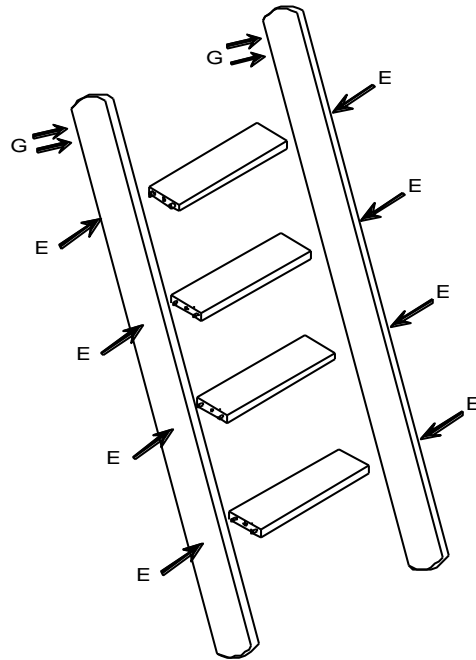

## 7 – Converting To Single Beds

### NB: 2 Persons Required

- 1) Remove the ladder.
- 2) Remove the screws locking the top bunk to the lower and lower the top bunk to the ground.
- 3) Remove the upper bunk safety rails.
- 4) Remove one end from each bunk (you shouldn't need to remove the mattress slats). Carefully turning the beds on their side will make access to the barrel nuts easier.
- 5) Attach a Headboard to what was previously the upper bunk and a Footboard to what was previously the lower bunk.
- 6) Finally locate the knobs and re-attach to the Headboard stems.

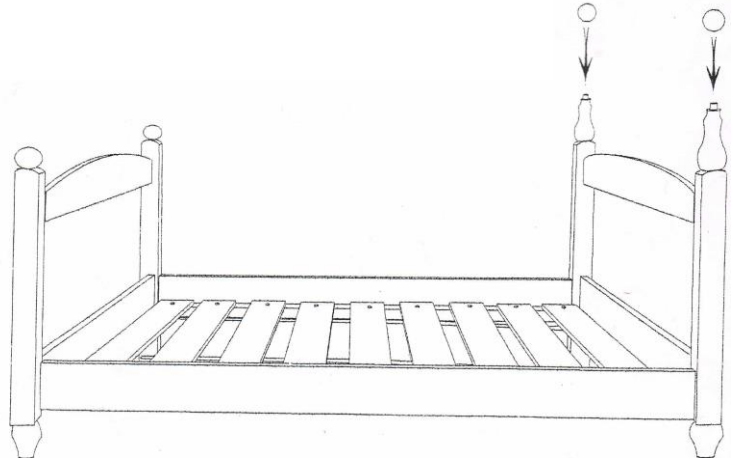

Manufactured in the UK